

Technische Daten: Art.-Nr.: 240 480 / 830 191 / 830 192 / 830 193 / 830 194

Wandaußenmaß: 390 x 390 cm

Bohlenstärke: 44 mm



**FARB-
BEHANDLUNG**

Fichte

Bernstein

Gletschergrau

Felsgrau

Kontrolliert durch:

Achtung: Alle angegebenen Maße sind ca.-Maße!

3D-Darstellung

Art.-Nr. 240 480 / 830 191 / 830 192 / 830 193 / 830 194



Grundriss

Art.-Nr. 240 480 / 830 191 / 830 192 / 830 193 / 830 194

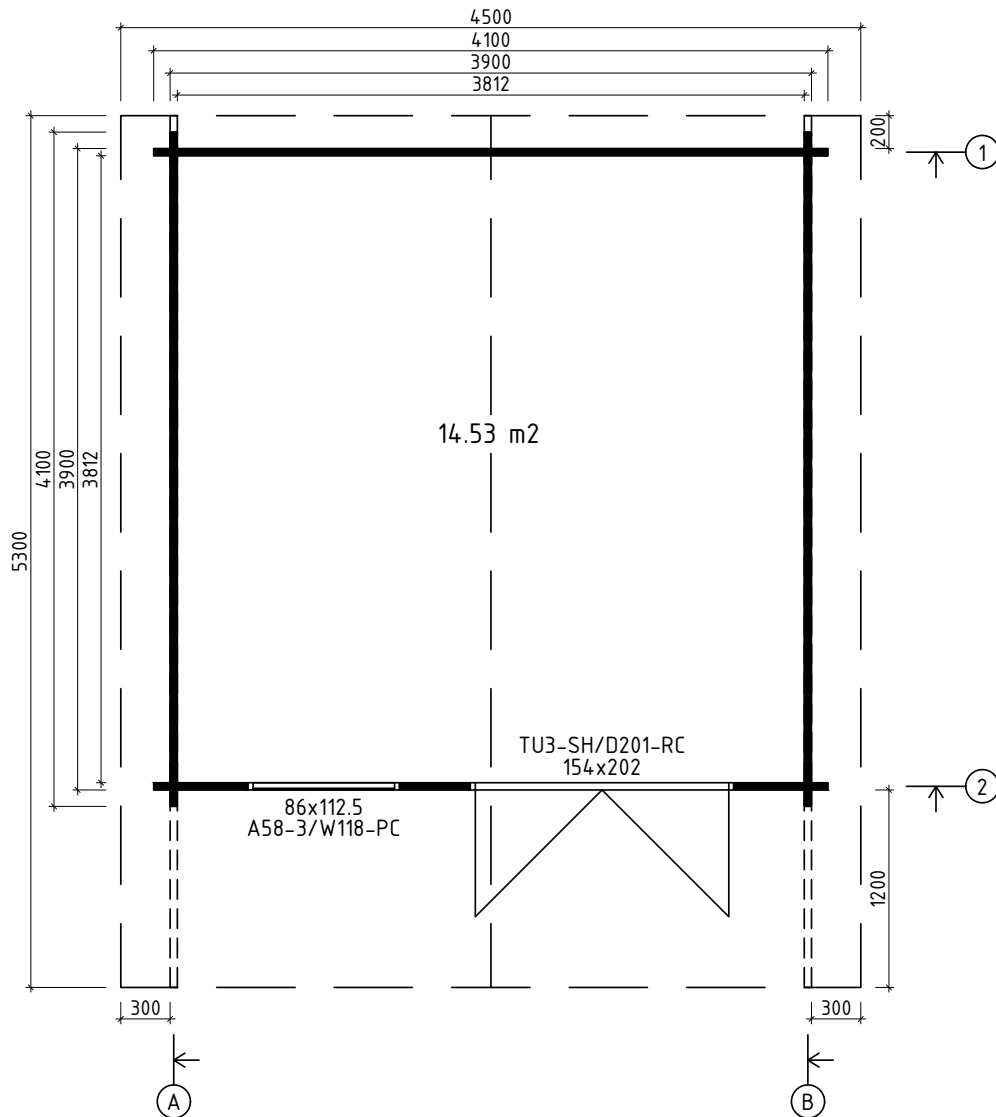

Q4 – Qualitätsklasse für Fenster und Türen

* Fenster und Türen sind mit Sprossen

Lagerholzplan und Fundamentplan





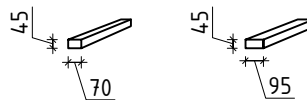
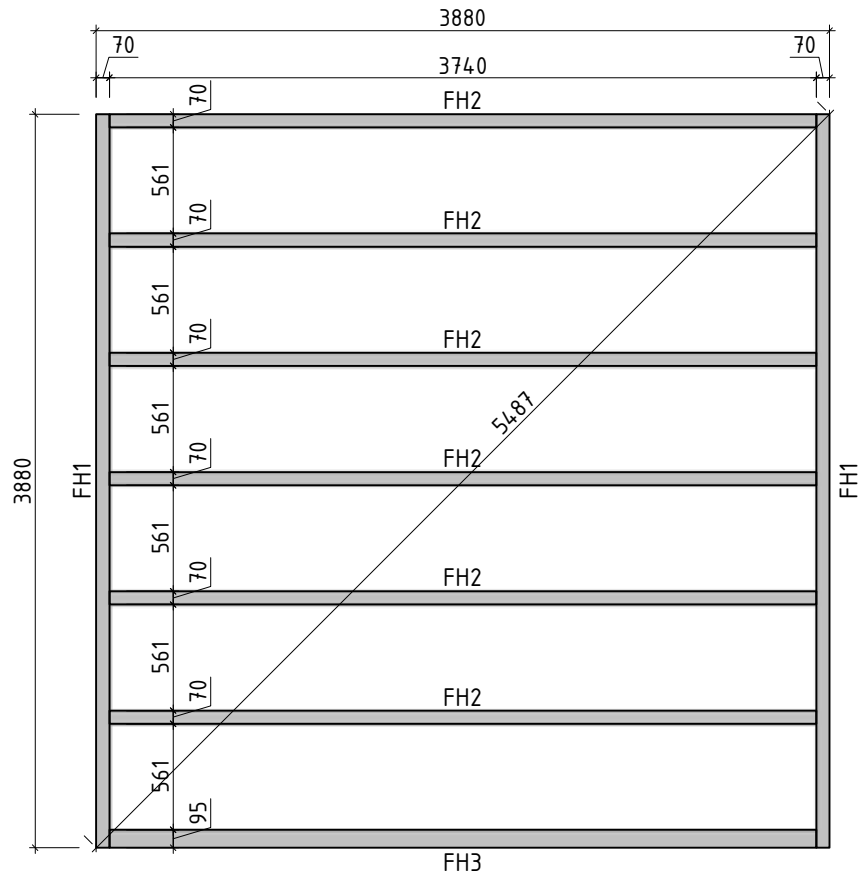

Art.-Nr. 240 480 / 830 191 / 830 192 / 830 193 / 830 194

Wir empfehlen als Fundament für Ihr Gartenhaus eine vollflächig festgegründete, gepflasterte oder betonierte Fläche.
Wahlweise ist auch ein Punkt- oder Streifenfundament möglich.

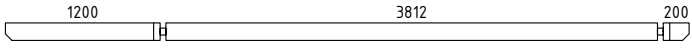
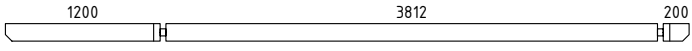
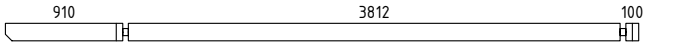
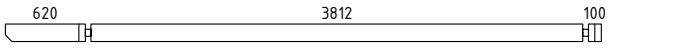
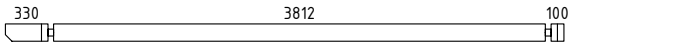
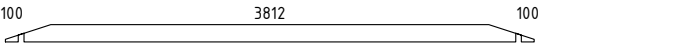
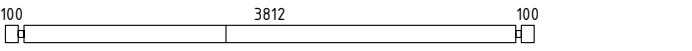
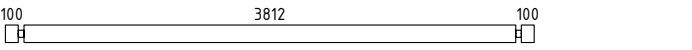
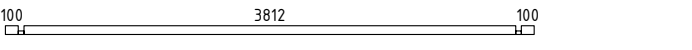
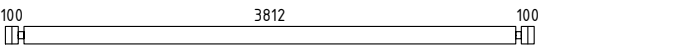
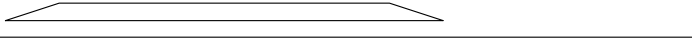
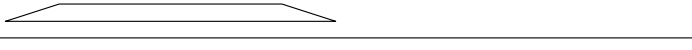
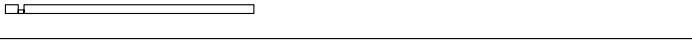
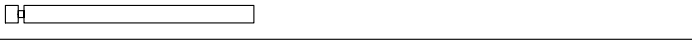

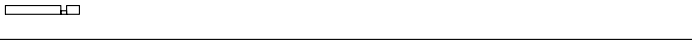

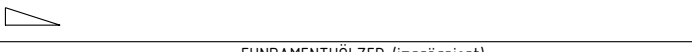
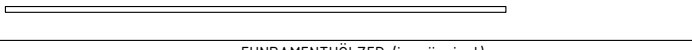
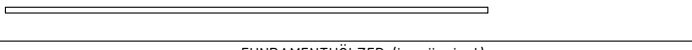

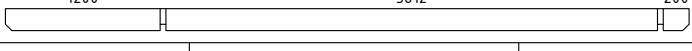





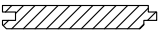
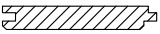





Teileliste 1

Art.-Nr. 240 480 / 830 191 / 830 192 / 830 193 / 830 194

Pos		Stck.	Profil (mm)	Länge (mm)
	Achtung! Die Giebelbohlen können teilweise schon vormontiert sein! Bitte beachten - diese erscheinen nicht ganz so wie in der Teileliste beschrieben.			
001		1	44x135	5300
002		1	44x135	5300
003		2	44x135	4910
004		2	44x135	4620
005		2	44x135	4330
006		2	44x135	4100
007		1	44x135	4100
008		16	44x135	4100
009		1	44x68	4100
010		26	44x135	4100
011		2	44x135	3395
012		2	44x135	2561
013		1	44x68	1926
014		5	44x135	1926
015		1	44x135	1926
016		2	44x135	1726
017		1	44x68	574
018		24	44x135	574
019		9	44x135	432
020		4	44x135	422
FH1	FUNDAMENTHÖLZER (imprägniert) 	2	70x45	3880
FH2	FUNDAMENTHÖLZER (imprägniert) 	6	70x45	3740
FH3	FUNDAMENTHÖLZER (imprägniert) 	1	95x45	3740
PF1	PFETTEN 	3	58x170	5300

Teilleiste 2

Art.-Nr. 240 480 / 830 191 / 830 192 / 830 193 / 830 194

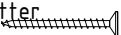
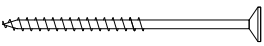
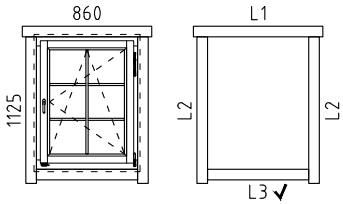
Pos		Stck	Profil (mm)	Länge (mm)
	DACHBRETTEN 	94+1	113x18	2365
	FUSSBODENBRETTEN 	34+1	113x18	3805
	FUSSBODENLEISTEN  ✓		18x40	17.0lfm
G02-1	GIEBELBRETTEN 18x120  17,9° ✓	4	18x120	2445
G06-1	GIEBELDECKLEISTEN 18x58  ✓	4	18x58	2445
T01-1	TRAUFBRETTEN 18x95 	2	18x95	5300
T06-1	TRAUFNLEISTEN 18x40  ✓		18x40	11.0lfm
GS	Giebelsegment 	2		
SH	Schlaghölzer 	3		
ML1	Metallstange 	1	D10	14.40
KL1	Gewindestange M8 	4		2000
KL2	Gewindestange M8 	4		325
KV M UT M8	Mutter M8 	8		
KV S EIB M8X25	U-Scheibe M8 Ø25 	8		
KV MU TJ M8	Befestigungsmutter M8 	4		
NG04	NÄGEL 2.5x50  Dachbretter Fußbodenbretter	1040		
SR32	SCHRAUBEN 3.0x30  Fußbodenleisten Traufenleisten 18x40	60		
SR37	SCHRAUBEN 3.5x45  Giebelbretter, Giebeldeckleisten, Traufenbretter Giebelsegment, Fenster- und Türleisten	118		
SR57	SCHRAUBEN 5.0x100  Fundamenthölzer	36		
	Q4 FENSTER  W4-S44P-06C-08601125	1		
	<p>A58-3/W118-PC</p> <p>L1 18x95 L=1100mm 2x L2 18x95 L=1245mm 4x L3 18x95 L=860mm 2x ✓</p>			

Wandplan 2

Art.-Nr. 240 480 / 830 191 / 830 192 / 830 193 / 830 194

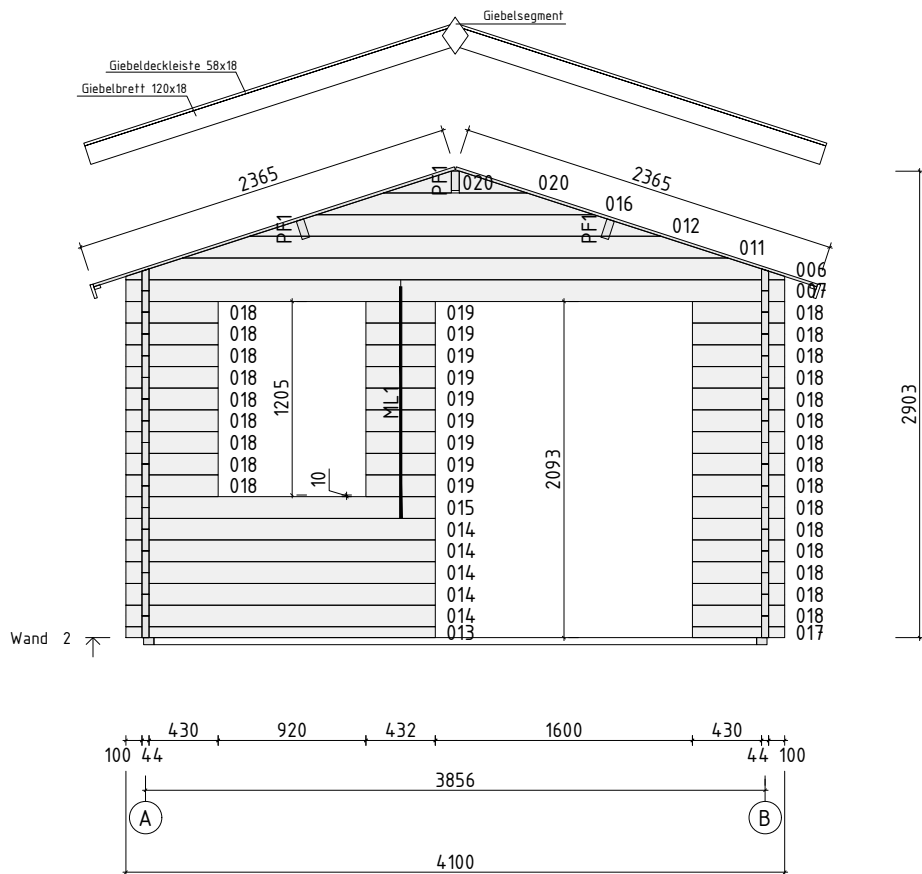

Wandplan A

Art.-Nr. 240 480 / 830 191 / 830 192 / 830 193 / 830 194

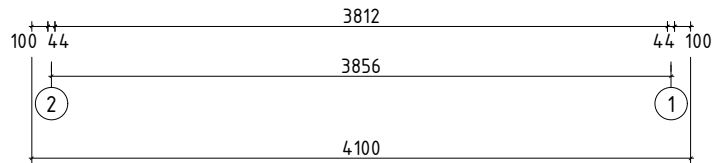
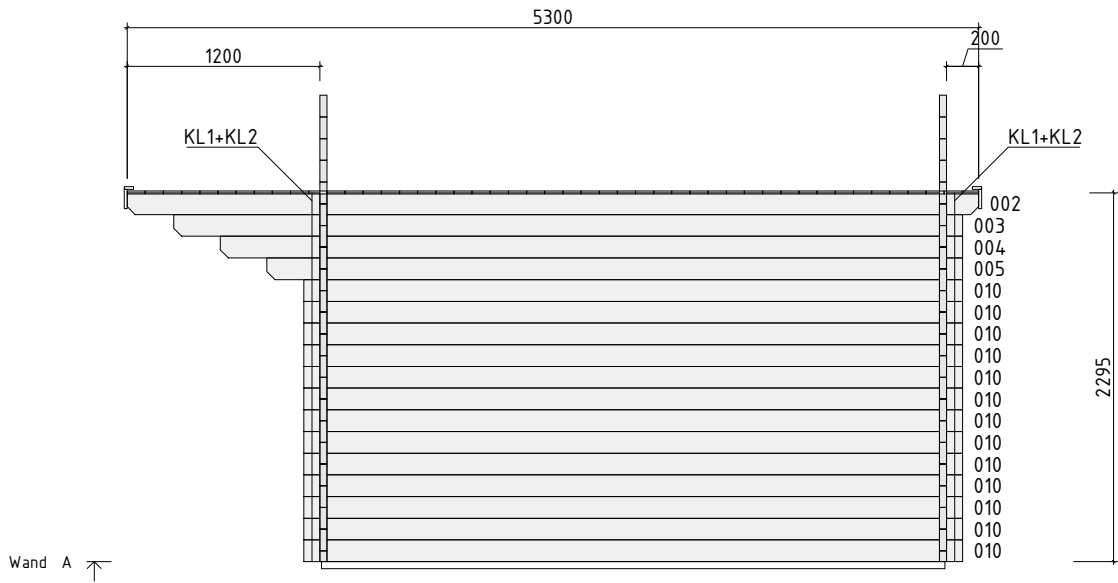
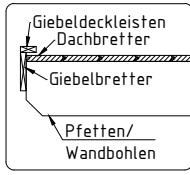

Wandplan B

Art.-Nr. 240 480 / 830 191 / 830 192 / 830 193 / 830 194

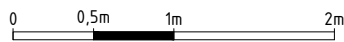
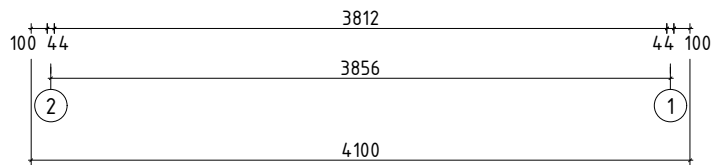
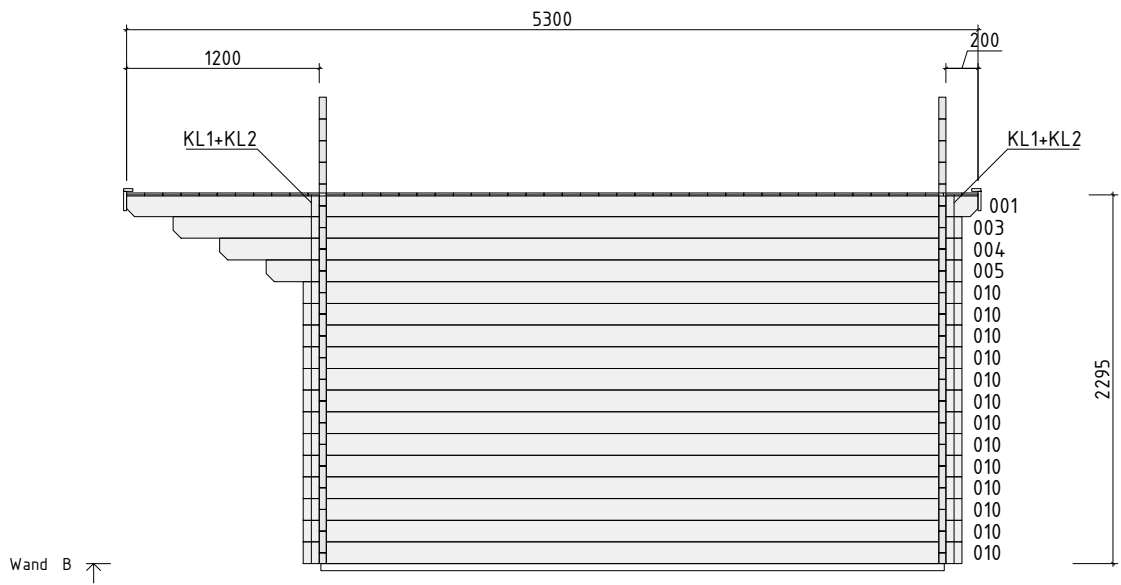

Fenstermontage

Art.-Nr. 240 480 / 830 191 / 830 192 / 830 193 / 830 194

Aken Q4-Q6 - paigaldusjuhised
Window Q4-Q6 - assembly instructions
Fenster Q4-Q6 - Montageanleitung

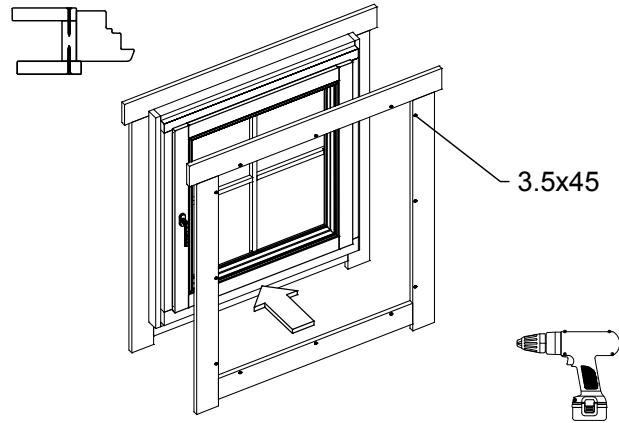
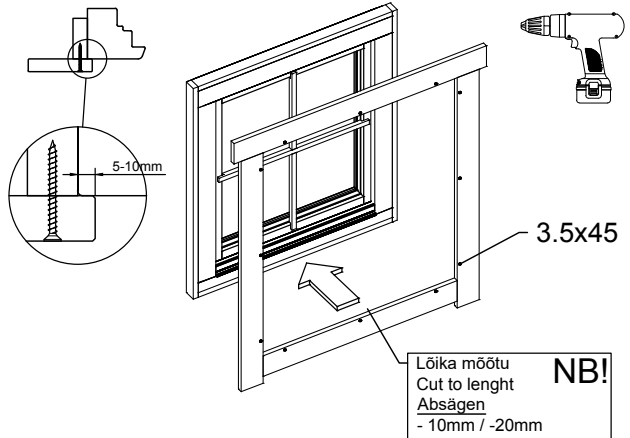
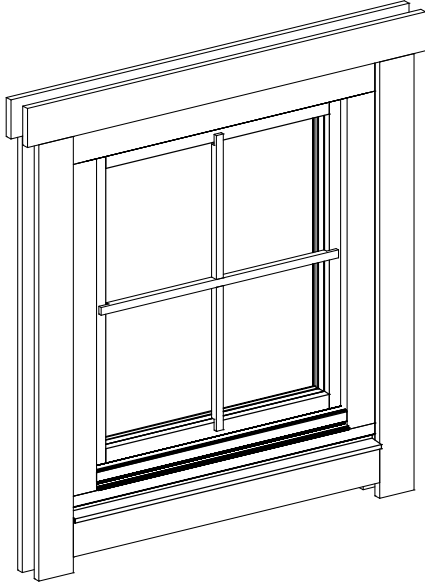

Fenstermontage

Art.-Nr. 240 480 / 830 191 / 830 192 / 830 193 / 830 194

Veeplekk / Window sill / Fensterbank

Q4

1

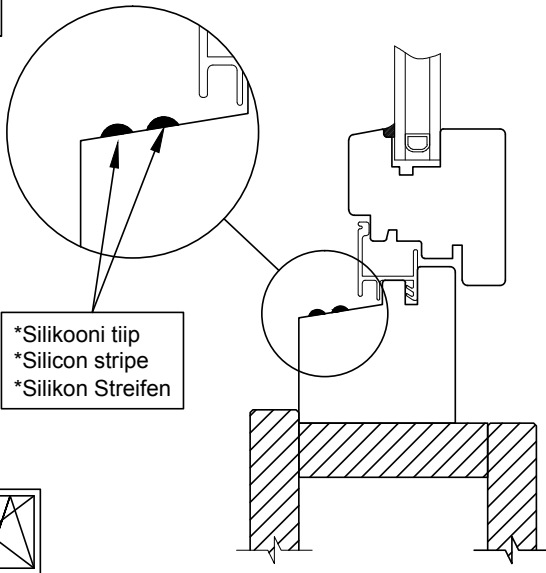

2

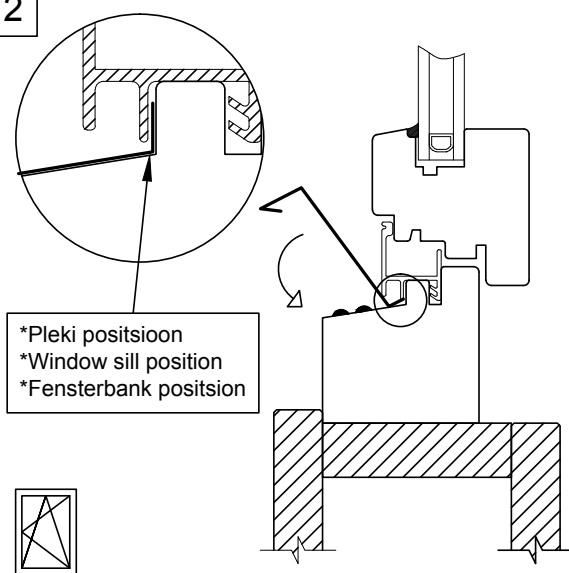

3

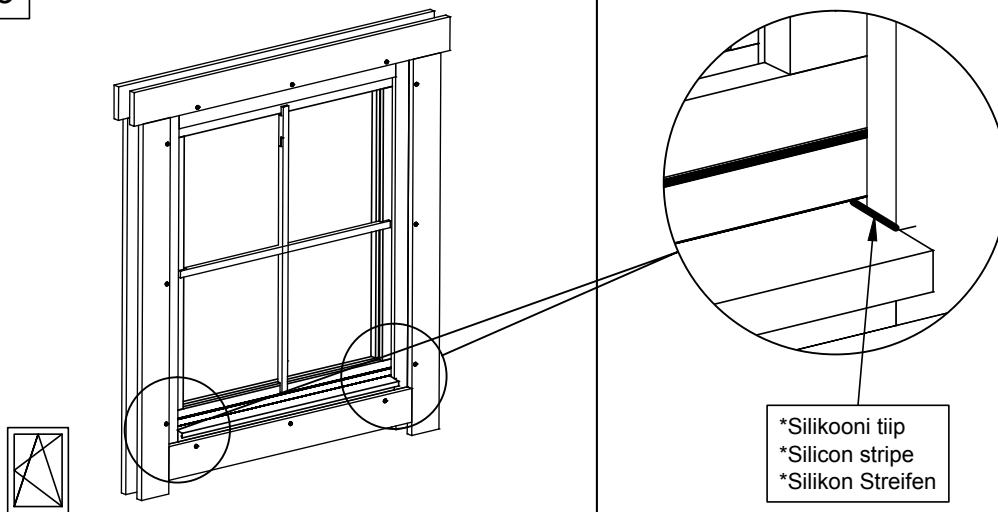

1

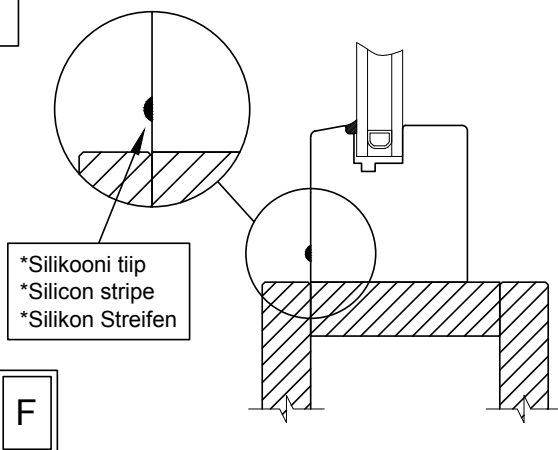

2

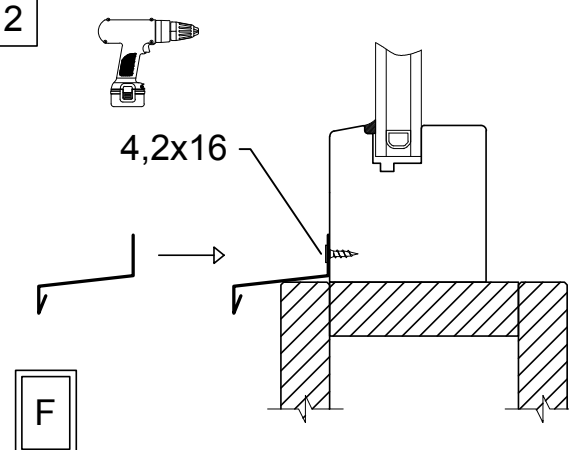

Türmontage

Art.-Nr. 240 480 / 830 191 / 830 192 / 830 193 / 830 194

Ukse montaaž / Tür montage / Door assembly
(GH+ / SH)

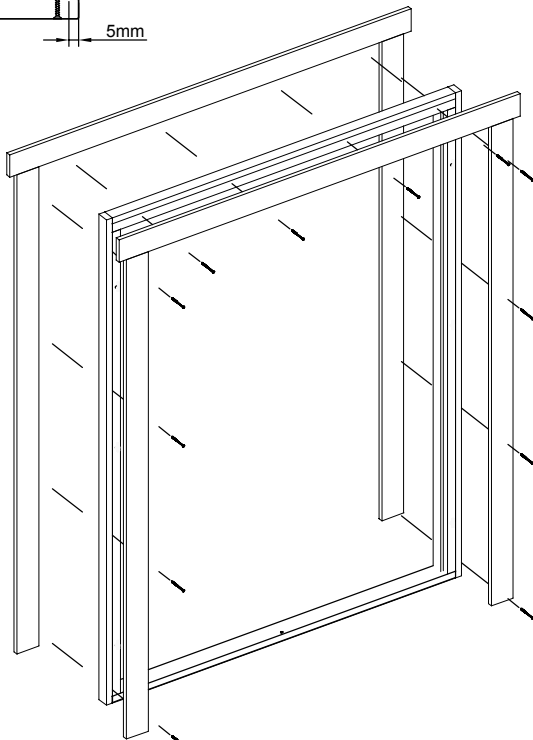
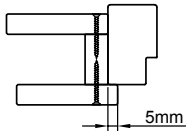
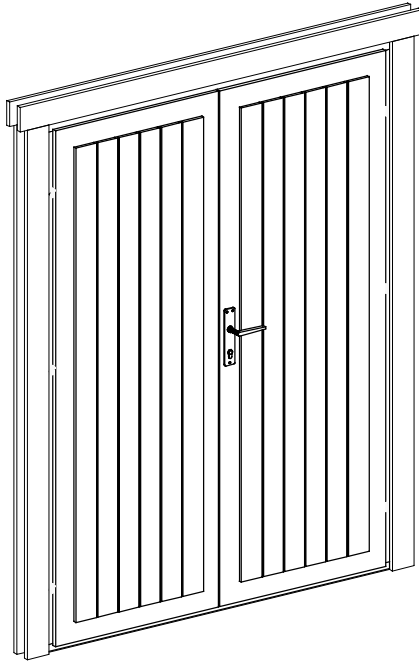

4.5x90

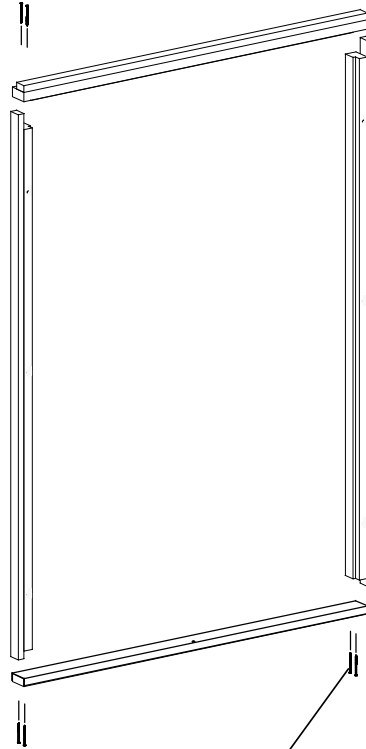

4.5x90

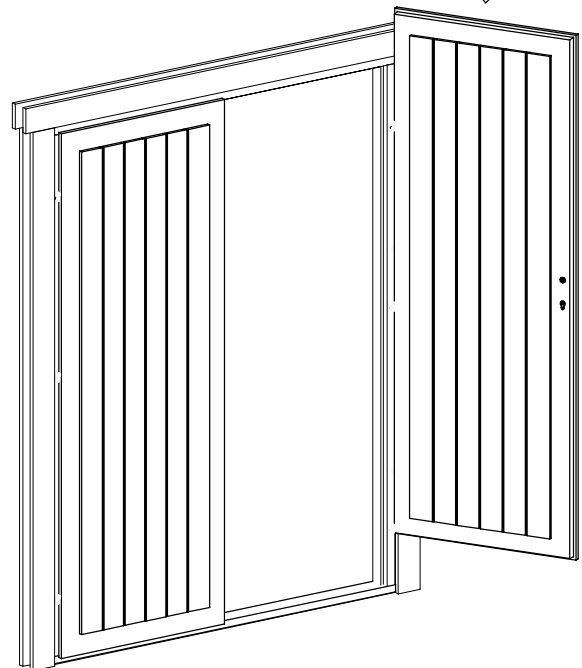
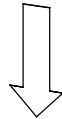

Türmontage

Art.-Nr. 240 480 / 830 191 / 830 192 / 830 193 / 830 194

